

4

3

2

1

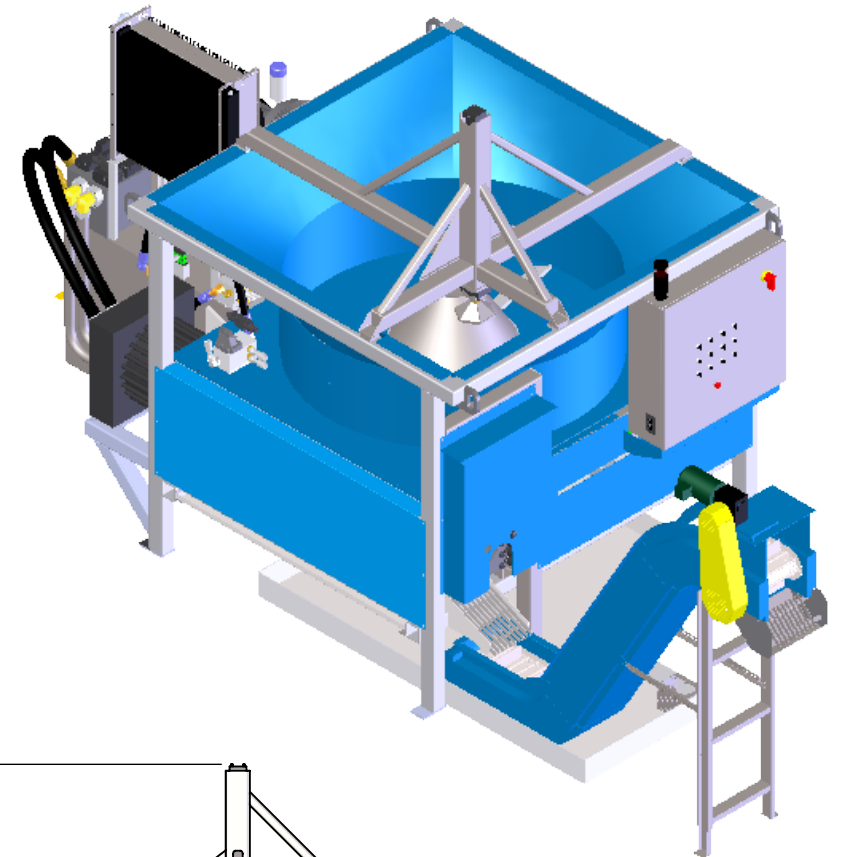
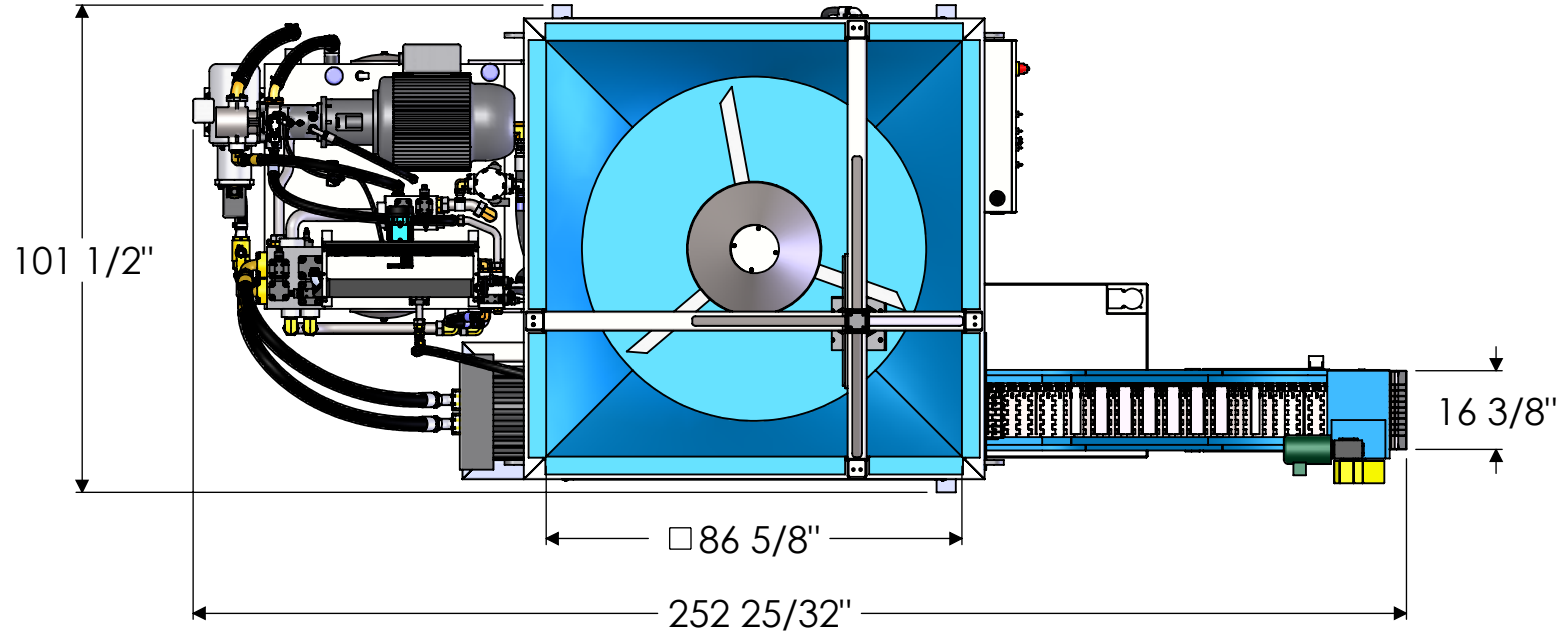

B

B

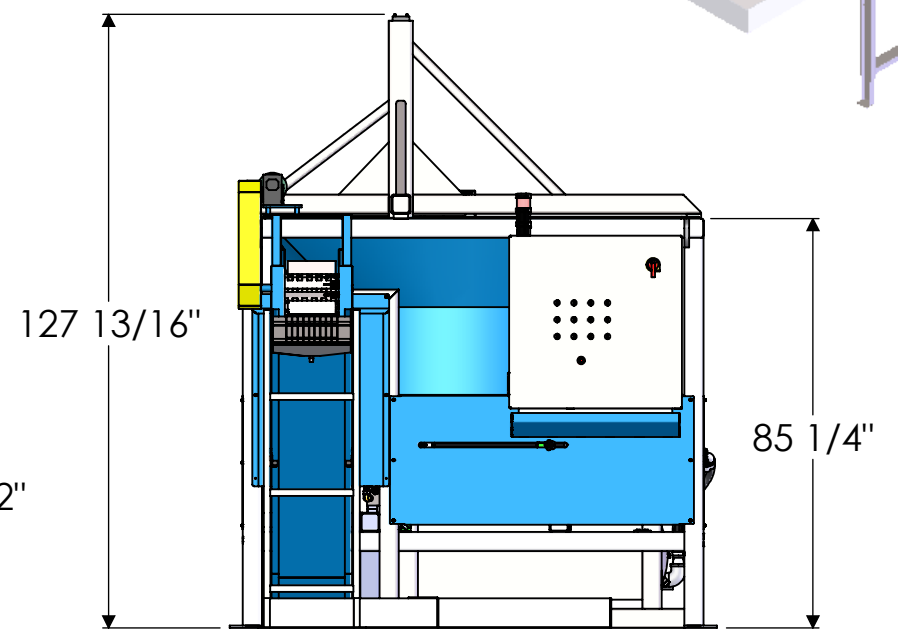
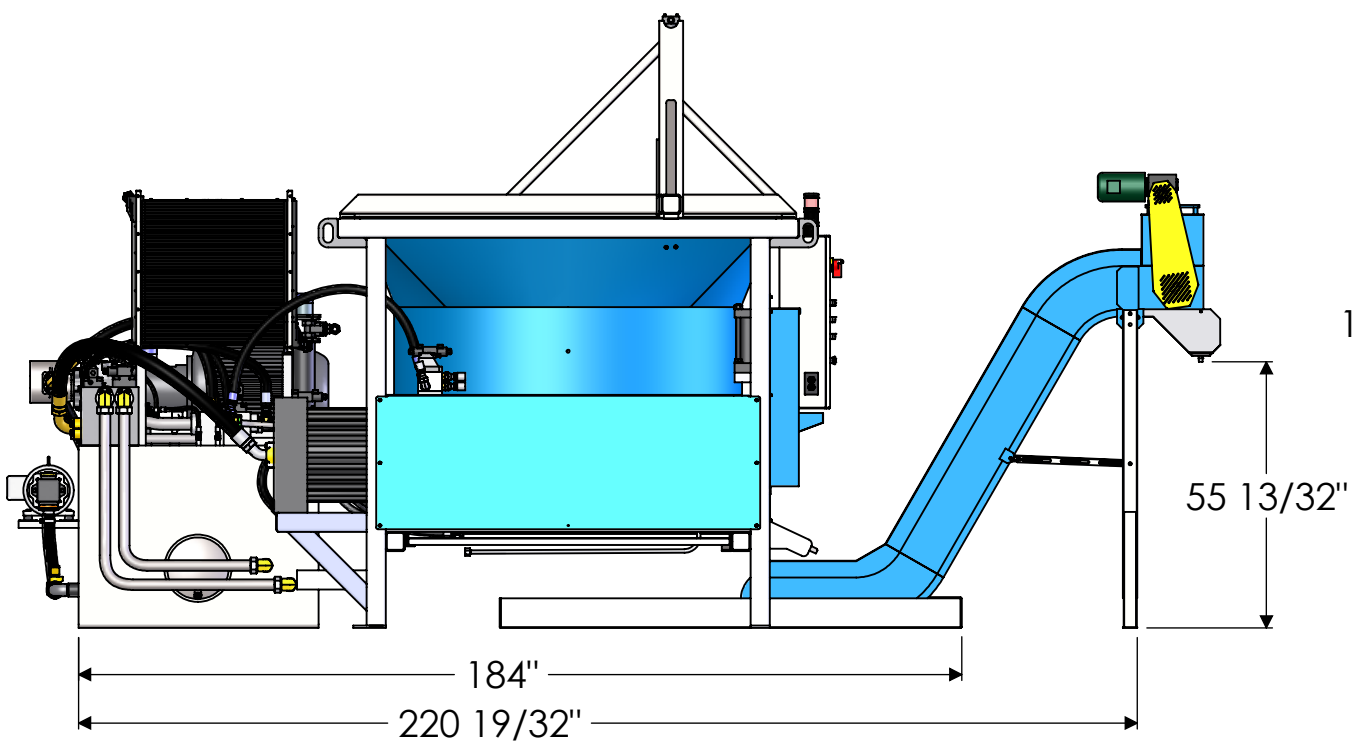
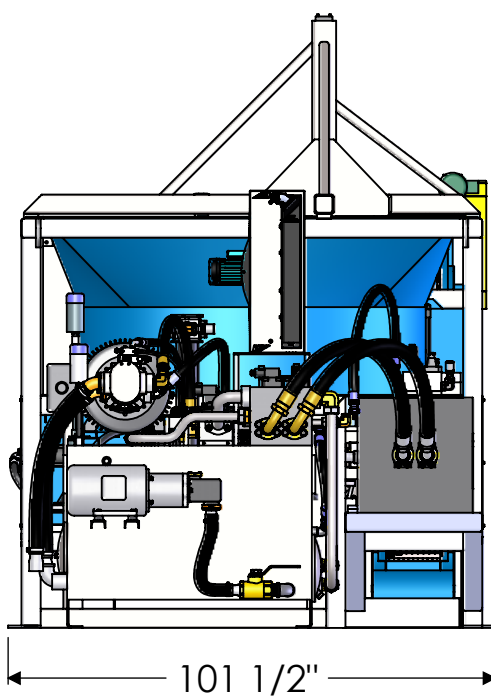

A

A

PROPRIETARY AND CONFIDENTIAL
 THE INFORMATION CONTAINED IN THIS
 DRAWING IS THE SOLE PROPERTY OF
 <INSERT COMPANY NAME HERE>. ANY
 REPRODUCTION IN PART OR AS A WHOLE
 WITHOUT THE WRITTEN PERMISSION OF
 <INSERT COMPANY NAME HERE> IS
 PROHIBITED.

		UNLESS OTHERWISE SPECIFIED:		NAME	DATE	 APPLIED RECOVERY SYSTEMS 9100 Van American Dr. Waco, Texas 76712
		TOLERANCES FRACTIONAL ± 1/32" DECIMAL .XX ± .010" DECIMAL .XXX ± .005" ANGULAR ± 1/2° MACHINED SURFACES TO BE FINISHED TO $\sqrt{125}$ UNLESS OTHERWISE SPECIFIED REMOVE ALL BURRS & SHARP EDGES		DRAWN	MAW	
		MATERIAL		ENG APPR.		TITLE: ARS 1500-LAYOUT
		SEE ABOVE		MFG APPR.		
NEXT ASSY	USED ON	FINISH		Q.A.		SIZE DWG. NO. REV B ARS 1500-LAYOUT
APPLICATION		DO NOT SCALE DRAWING		COMMENTS:		SCALE: 1:40 WEIGHT: SHEET 1 OF 1

4

3

2

1